

Part #	Prepared By
Project	Notes
Type	
Date	

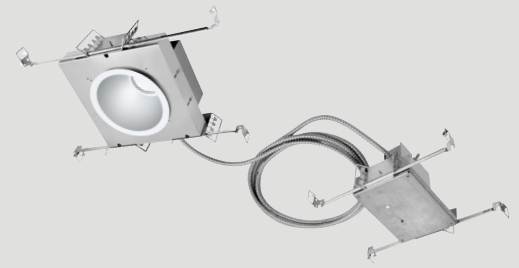

6" Round, vHealth® MRI

Open, LED Downlight, MRI, 750-7000 Lumens



Description

vHealth® MRI luminaires are made with non-ferrous metals to ensure safe and reliable operation in medical imaging suites. Separate light module and fixture housings enable easy installation of the remote power supply. vHealth® MRI lights come standard with antimicrobial trim finishes to help mitigate infection risks throughout medical facilities. Optional EMI Filter available for turnkey solution. Open vHealth® MRI recessed downlights provide the sharpest cutoff to reduce glare and eye shock potential for patients and technicians.

Warranty & Notes

ELECTRICAL SYSTEM

- 750 - 7000 lumens
- 2700K - 5000K CCT
- 80 CRI with 3 SDCM color consistency (+90 CRI optional)
- Standard 0-10V 1% dimming driver; optional drivers available
- 120 - 277V
- Minimum 50,000 hour lifetime at L70
- -20°C to 30°C Ambient Operating Temperature Range

OPTICS

- Precision spun architectural-grade reflector
- Reflectors available in Alzak® and painted finishes; Antimicrobial standard
- Distribution is free of streaks, striations and hotspots
- Medium distribution
- 45° Cutoff

FRAME & MOUNTING

- Non-Ferrous frame with integrated junction box featuring hinged access covers with spring retaining latches
- Vertically adjustable rigid formed mounting brackets that accept a variety of mounting bars with auxiliary nail holes and T-bar slots
- T-Bars included, suitable for joist spacing from 12" to 24"
- Supports straight conduit runs (3) 3/4" knockouts
- Through branch wiring - (8) #12 AWG (4 in, 4 out), 90°C conductors
- Accessibility to all LED components from below ceiling
- Flush to the ceiling reflectors, secured by high quality friction clips

Listings

- ETL certified to UL 1598 and UL8750 requirements
- Tested according to LM-79 and LM-80 standards
- Energy Star® certified versions available (see Vantage Energy Star® guide for details)
- Suitable for damp locations; Wet location under covered ceiling
- Buy American Act

Warranty & Notes

- 5-year limited warranty on LED module and driver, www.vantageltg.com/product-warranty
- Photometric tests performed by an accredited NVLP facility and in accordance to IESNA LM-79-2008 testing procedures
- Insulation cannot be in direct contact with luminaire

Ordering Information

EXAMPLE: V6OVHMRIU-1130K-M6060-SGC-AM-TDM

V6OVHMRI				M6060		
Series	Voltage	Lumens	Kelvin (CCT)	Reflector	Antimicrobial Finishes	Options**
V6OVHMRI	U - 120V-277V 1 - 120V 2 - 277V *Must provide voltage when optional drivers are selected.	07 - 750 11 - 1100 15 - 1500 20 - 2000 30 - 3000 40 - 4000 50 - 5000 60 - 6000 70 - 7000	27K - 2700K 30K - 3000K 35K - 3500K 40K - 4000K 50K - 5000K	M6060 Medium Beam Open Reflector	SCL-AM Specular Clear Antimicrobial SGC-AM Soft Glow Clear Antimicrobial WHT-AM White Matte Antimicrobial *All trims supplied standard with white painted flange.	VEM12 VEM14 DTD TDM DL-2 DL-3 LDE1 LDES PEQ0 HCR PF EM-17 EM-20

*Options Notes

- VEM12 - 2-Port EMI Filter
- VEM14 - 4-Port EMI Filter
- DTD - 0-10V 0.1% dimming driver. Not available above 4000 lumens.
- TDM - Triac (Forward Phase, 120V only) dimming driver. Not available above 5000 lumens.
- DL-2 - Lutron 2-Wire Hi-Lume dimming driver. Not available above 3000 lumens.
- DL-3 - Lutron 3 wire Hi-Lume dimming driver. Not available above 3000 lumens.
- LDE1 - Lutron Hi-lume 1% with Soft-On, Fade-to-Black dimming driver. Not available above 4000 lumens.
- LDES - Lutron 5-Series 5% dimming driver. Not available above 4000 lumens.
- PEQ0 - Lutron Hi-lume Premier 0.1% with Soft-On, Fade-to-Black dimming driver. Not available above 4000 lumens.
- HCR - High CRI, 90+ minimum. Not available in 5000 Kelvin.
- PF - Polished Flange
- EM-17 - Emergency battery back-up. Remote test button & indicator light. For 750-5000 lumen luminaires.
- EM-20 - Emergency batter back-up. Remote test button & indicator light. For 6000 & 7000 lumen luminaires.

Vantage reserves the right to change components, finishes or design details in any manner which does not alter the installed appearance or reduce performance and intended function.

vHealth® is a registered trademark of Lexington Lighting Group, LLC dba Vantage Lighting

6" Round, vHealth® MRI

Open, LED Downlight, MRI, 750-7000 Lumens

Dimensional Data

Above Ceiling Height with 5/8" Ceiling
 • 4.13" ≤ 3000L
 • 4.33" 4000L & 5000L

Above Ceiling Height
 • Max Ceiling Thickness 1.18" - 3.57"
 • Min Ceiling Thickness 0.20" - 4.55"

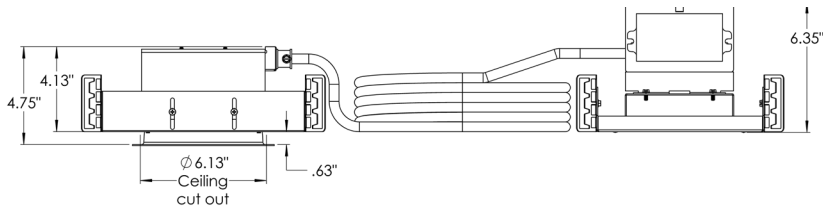

Above Ceiling Height with 5/8" Ceiling
 • 6.76" 6000L & 7000L

Above Ceiling Height
 • Max Ceiling Thickness 1.18" - 6.20"
 • Min Ceiling Thickness 0.20" - 7.19"

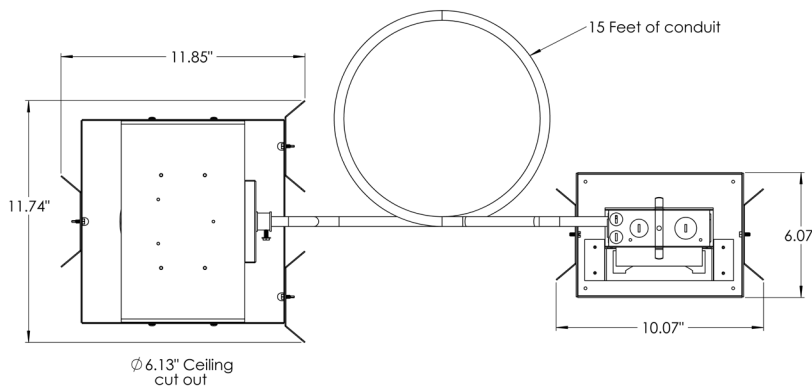
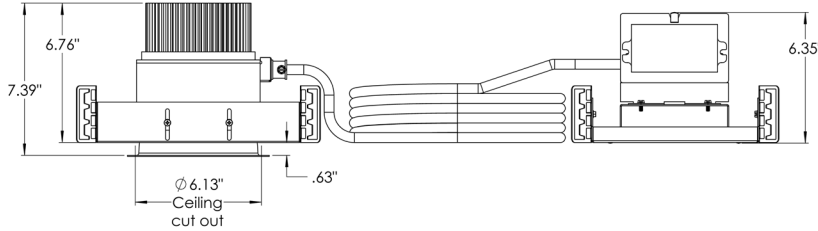

Photometry

Model
 V6OVHMRIU-2035K-M6060-SCL-AM

Candela Curve

Lumens

1,921

Watts

25.8

Efficacy

74.46

SC

0.89

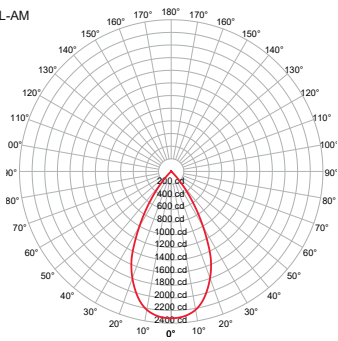

Cone of Light

Mounting Height AFF	FC at Center on Floor	Beam Diameter
8.0'	36 fc	8.6'
10.0'	23 fc	10.8'
12.0'	16 fc	12.9'
14.0'	12 fc	15.1'
16.0'	9 fc	17.2'
20.0'	6 fc	21.5'
24.0'	4 fc	25.8'
30.0'	3 fc	32.3'

Candela Table

	0.00°
0.00°	2,322
5.00°	2,302
10.00°	2,223
15.00°	2,050
20.00°	1,796
30.00°	1,010
40.00°	275
50.00°	25
60.00°	10
70.00°	5
80.00°	2
90.00°	0

Zonal Lumen Summary

Zone	Lumens	% Luminaire
0° - 30°	1,442	75%
0° - 40°	1,819	95%
0° - 60°	1,910	99%
60° - 90°	11	1%
0° - 20°	788	41%
20° - 50°	1,107	58%
50° - 70°	22	1%
70° - 90°	4	0%
0° - 90°	1,921	100%
90° - 180°	0	0%
Total	1,921	100%

Spacing Criterion

Height	Spacing	Light Level*
8 ft	7.1 ft	~ 36 fc
10 ft	8.9 ft	~ 23 fc
12 ft	10.7 ft	~ 16 fc
8 ft	5.3 ft	~ 65 fc
10 ft	6.7 ft	~ 41 fc
12 ft	8.0 ft	~ 29 fc
8 ft	3.6 ft	~ 145 fc
10 ft	4.5 ft	~ 93 fc
12 ft	5.3 ft	~ 65 fc

* approximate direct light level at floor based on spacing criterion overlap

Multiplier

CRI	Multiplier	Kelvin	Multiplier	Reflector Finish	Multiplier
80	1	2700K	0.939	SCL	1
90	0.8	3000K	0.975	SGC	0.95
		3500K	1	WHT	0.87
		4000K	10.35		
		5000K	1.098		

Vantage reserves the right to change components, finishes or design details in any manner which does not alter the installed appearance or reduce performance and intended function.

vHealth® is a registered trademark of Lexington Lighting Group, LLC dba Vantage Lighting



VEM12 - 2-Port EMI Filter

VEM14 - 4-Port EMI Filter

APPLICATIONS

- MRI Rooms

MATERIALS

- Steel Enclosure
- Steel Threaded Pipe
- Easy Connect Terminal Blocks

ELECTRICAL

- Calss II output 100W
- 3A / up to 40VDC

SPECIFICATIONS

- Filter provides >100dB attenuation between 10Khz - 1Ghz on 0-10V dimming circuits
- Operating temperature rating: -10°C to + 60°C

MECHANICAL (DIMENSIONS - INCHES)

PART NUMBER	DESCRIPTION	LENGTH	WIDTH	DEPTH
VEM12	2-Port EMI Filter	8.70"	3.98"	1.93"
VEM14	4-Port EMI Filter	8.70"	6.73"	1.93"

VEM12 - 2-Port EMI Filter

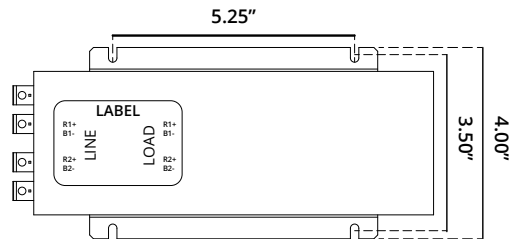
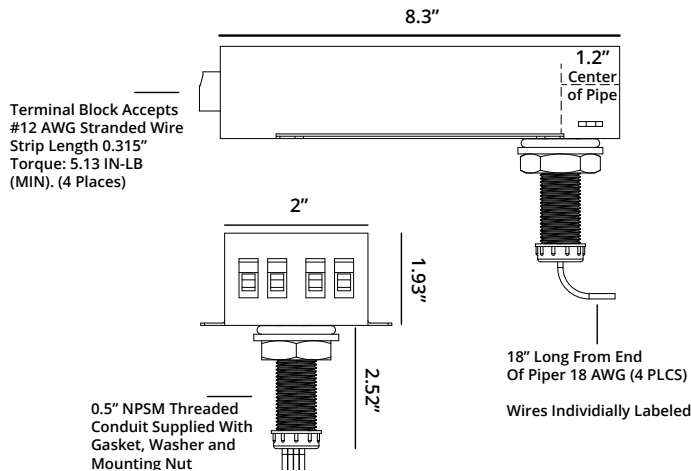

ELECTRICAL SCHEMATIC

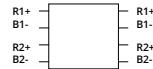

VEM14 - 4-Port EMI Filter

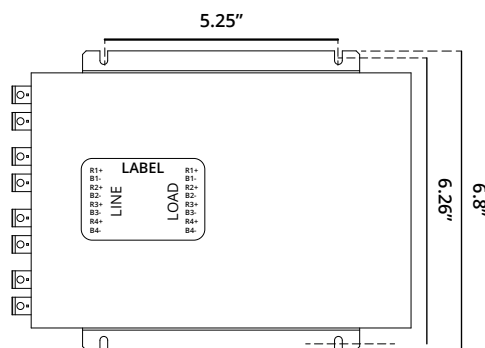
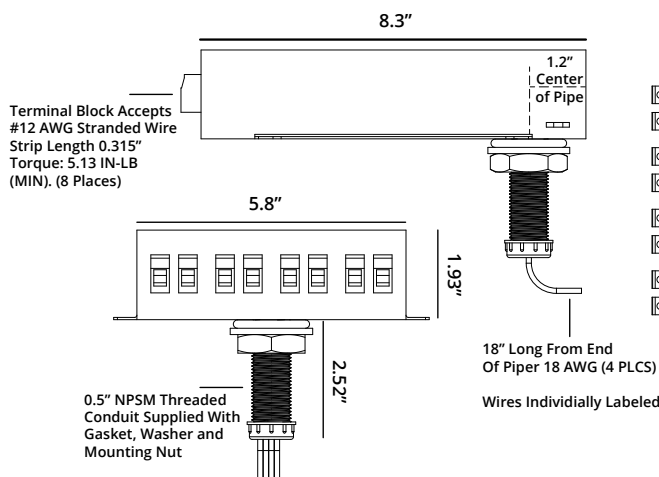

ELECTRICAL SCHEMATIC

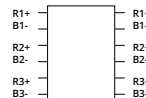

Vantage reserves the right to change components, finishes or design details in any manner which does not alter the installed appearance or reduce performance and intended function.

vHealth® is a registered trademark of Lexington Lighting Group, LLC dba Vantage Lighting