

Part #	Prepared By
Project	Notes
Type	
Date	

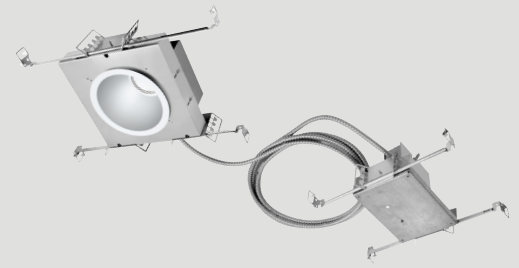

# 8" Round, vHealth® MRI

## Open, LED Downlight, MRI, 750-7000 Lumens



### Description

vHealth® MRI luminaires are made with non-ferrous metals to ensure safe and reliable operation in medical imaging suites. Separate light module and fixture housings enable easy installation of the remote power supply. vHealth® MRI lights come standard with antimicrobial trim finishes to help mitigate infection risks throughout medical facilities. Optional EMI Filter available for turnkey solution. Open vHealth® MRI recessed downlights provide the sharpest cutoff to reduce glare and eye shock potential for patients and technicians.

### Warranty & Notes

#### ELECTRICAL SYSTEM

- 750 - 7000 lumens
- 2700K - 5000K CCT
- 80 CRI with 3 SDCM color consistency (+90 CRI optional)
- Standard 0-10V 1% dimming driver; optional drivers available
- 120V - 277V
- Minimum 50,000 hour lifetime at L70
- -20°C to 30°C Ambient Operating Temperature Range

#### OPTICS

- Precision spun architectural-grade reflector
- Reflectors available in Alzak® and painted finishes; Antimicrobial standard
- Distribution is free of streaks, striations and hotspots
- Medium distribution
- 45° Cutoff

### FRAME & MOUNTING

- Non-Ferrous frame with integrated junction box featuring hinged access covers with spring retaining latches
- Vertically adjustable rigid formed mounting brackets that accept a variety of mounting bars with auxiliary nail holes and T-bar slots
- T-Bars included, suitable for joist spacing from 12" to 24"
- Supports straight conduit runs (3) 3/4" knockouts
- Through branch wiring - (8) #12 AWG (4 in, 4 out), 90°C conductors
- Accessibility to all LED components from below ceiling
- Flush to the ceiling reflectors, secured by high quality friction clips

### Listings

- ETL certified to UL 1598 and UL8750 requirements
- Tested according to LM-79 and LM-80 standards
- Energy Star® certified versions available (see Vantage Energy Star® guide for details)
- Suitable for damp locations; Wet location under covered ceiling
- Buy American Act

### Warranty & Notes

- 5-year limited warranty on LED module and driver, [www.vantageltg.com/product-warranty](http://www.vantageltg.com/product-warranty)
- Photometric tests performed by an accredited NVLP facility and in accordance to IESNA LM-79-2008 testing procedures
- Insulation cannot be in direct contact with luminaire

### Ordering Information

EXAMPLE: V8OVHMRIU-1130K-MRI8060-SGC-AM-TDM

Series	Voltage	Lumens	Kelvin (CCT)	Reflector	Antimicrobial Finishes	Options**
V8OVHMRI	U - 120V-277V 1 - 120V 2 - 277V  *Must provide voltage when optional drivers are selected.	07 - 750 11 - 1100 15 - 1500 20 - 2000 30 - 3000 40 - 4000 50 - 5000 60 - 6000 70 - 7000	27K - 2700K 30K - 3000K 35K - 3500K 40K - 4000K 50K - 5000K	MRI8060 Medium Beam Open Reflector	SCL-AM Specular Clear Antimicrobial SGC-AM Soft Glow Clear Antimicrobial WHT-AM White Matte Antimicrobial  *All trims supplied standard with white painted flange.	VEM12 VEM14 DTD TDM DL-2 DL-3 LDE1 LDE5 PEQ0 HCR PF EM-17 EM-20

#### \*Options Notes

- VEM12 - 2-Port EMI Filter
- VEM14 - 4-Port EMI Filter
- DTD - 0-10V 0.1% dimming driver. Not available above 4000 lumens.
- TDM - Triac (Forward Phase, 120V only) dimming driver. Not available above 5000 lumens.
- DL-2 - Lutron 2-Wire Hi-Lume dimming driver. Not available above 3000 lumens.
- DL-3 - Lutron 3 wire Hi-Lume dimming driver. Not available above 3000 lumens.
- LDE1 - Lutron Hi-Lume 1% with Soft-On, Fade-to-Black dimming driver. Not available above 4000 lumens.
- LDE5 - Lutron 5-Series 5% dimming driver. Not available above 4000 lumens.
- PEQ0 - Lutron Hi-Lume Premier 0.1% with Soft-On, Fade-to-Black dimming driver. Not available above 4000 lumens.
- HCR - High CRI, 90+ minimum. Not available in 5000 Kelvin.
- PF - Polished Flange
- EM-17 - Emergency battery back-up. Remote test button & indicator light. For 750-5000 lumen luminaires.
- EM-20 - Emergency batter back-up. Remote test button & indicator light. For 6000 & 7000 lumen luminaires.

Vantage reserves the right to change components, finishes or design details in any manner which does not alter the installed appearance or reduce performance and intended function.

vHealth® is a registered trademark of Lexington Lighting Group, LLC dba Vantage Lighting

# 8" Round, vHealth® MRI

Open, LED Downlight, MRI, 750-7000 Lumens

## Dimensional Data

Above Ceiling Height with 5/8" Ceiling  
 • 5.55" ≤ 3000L  
 • 5.75" 4000L & 5000L

Above Ceiling Height  
 • Max Ceiling Thickness 1.25" - 4.93"  
 • Min Ceiling Thickness 0.20" - 5.98"

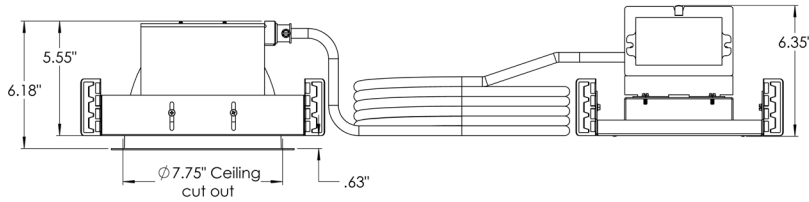

Above Ceiling Height with 5/8" Ceiling  
 • 8.19" 6000L & 7000L

Above Ceiling Height  
 • Max Ceiling Thickness 1.25" - 7.56"  
 • Min Ceiling Thickness 0.20" - 8.61"

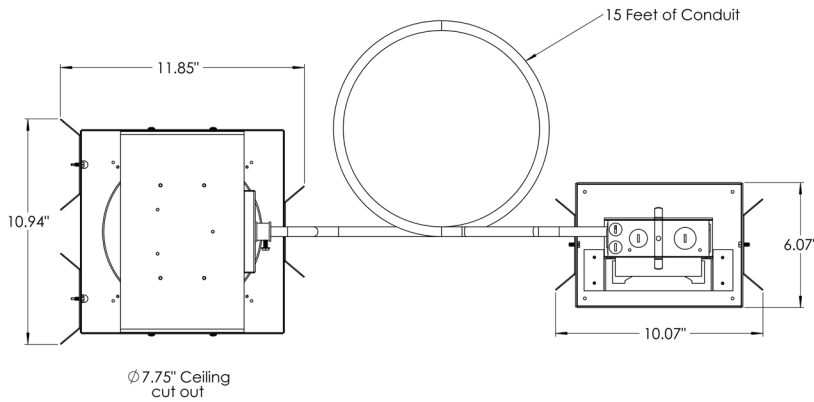
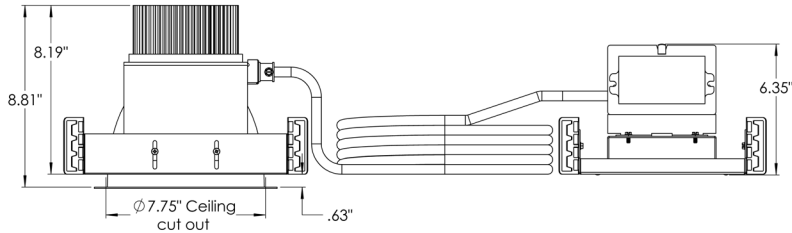

## Photometry

**Model**  
 V8OVHMRIU-2035K-MRI8060-SCL-AM

**Lumens**  
 1,800

**Watts**  
 27.2

**Efficacy**  
 66.18

**SC**  
 1.15

**Candela Curve**

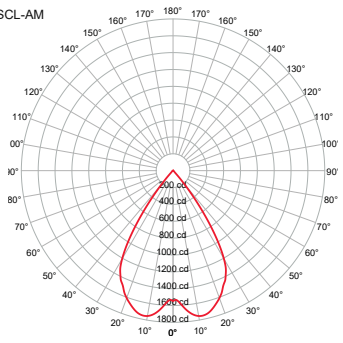

**Cone of Light**

Mounting Height AFF	FC at Center on Floor	Beam Diameter
8.0'	24 fc	10.6'
10.0'	15 fc	13.2'
12.0'	11 fc	15.8'
14.0'	8 fc	18.5'
16.0'	6 fc	21.1'
20.0'	4 fc	26.4'
24.0'	3 fc	31.7'
30.0'	2 fc	39.6'

**Candela Table**

0.00°	0.00°
0.00°	1,545
5.00°	1,644
10.00°	1,751
15.00°	1,723
20.00°	1,609
30.00°	1,207
40.00°	212
50.00°	19
60.00°	9
70.00°	5
80.00°	2
90.00°	0

**Zonal Lumen Summary**

Zone	Lumens	% Luminaire
0° - 30°	1,303	72%
0° - 40°	1,732	96%
0° - 60°	1,789	99%
60° - 90°	11	1%
0° - 20°	643	36%
20° - 50°	1,135	63%
50° - 70°	19	1%
70° - 90°	4	0%
0° - 90°	1,800	100%
90° - 180°	0	0%
<b>Total</b>	<b>1,800</b>	<b>100%</b>

**Spacing Criterion**

Height	Spacing	Light Level*
8 ft	9.2 ft	~ 24 fc
10 ft	11.5 ft	~ 15 fc
12 ft	13.8 ft	~ 11 fc
8 ft	6.9 ft	~ 43 fc
10 ft	8.6 ft	~ 27 fc
12 ft	10.3 ft	~ 19 fc
8 ft	4.6 ft	~ 97 fc
10 ft	5.8 ft	~ 62 fc
12 ft	6.9 ft	~ 43 fc

\* Approximate direct light level at floor based on spacing criterion overlap

## Multiplier

CRI	Multiplier	Kelvin	Multiplier	Reflector Finish	Multiplier
80	1	2700K	0.939	SCL	1
90	0.8	3000K	0.975	SGC	0.95
		3500K	1	WHT	0.87
		4000K	10.35		
		5000K	1.098		

Vantage reserves the right to change components, finishes or design details in any manner which does not alter the installed appearance or reduce performance and intended function.

vHealth® is a registered trademark of Lexington Lighting Group, LLC dba Vantage Lighting



### VEMI2 - 2-Port EMI Filter

### VEMI4 - 4-Port EMI Filter

#### APPLICATIONS

- MRI Rooms

#### MATERIALS

- Steel Enclosure
- Steel Threaded Pipe
- Easy Connect Terminal Blocks

#### ELECTRICAL

- Calss II output 100W
- 3A / up to 40VDC

#### SPECIFICATIONS

- Filter provides >100dB attenuation between 10Khz - 1Ghz on 0-10V dimming circuits
- Operating temperature rating: -10°C to + 60°C

#### MECHANICAL (DIMENSIONS - INCHES)

PART NUMBER	DESCRIPTION	LENGTH	WIDTH	DEPTH
VEMI2	2-Port EMI Filter	8.70"	3.98"	1.93"
VEMI4	4-Port EMI Filter	8.70"	6.73"	1.93"

### VEMI2 - 2-Port EMI Filter

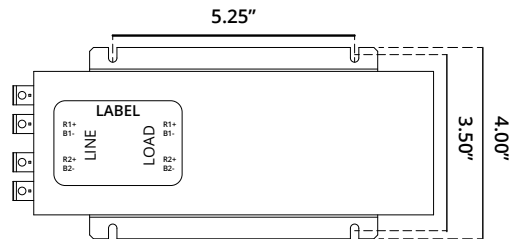
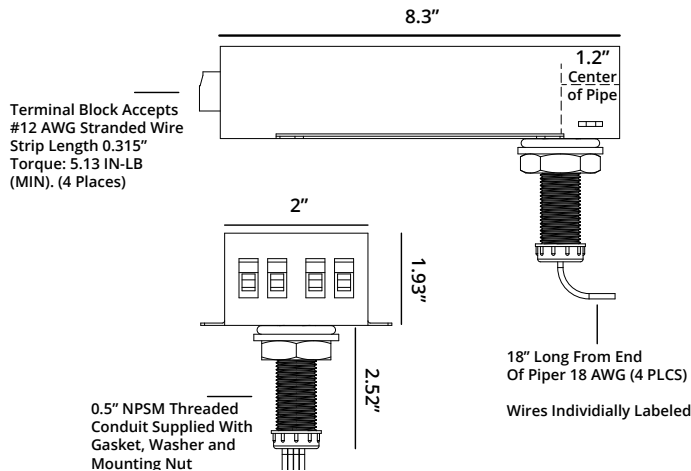

#### ELECTRICAL SCHEMATIC

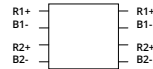

### VEMI4 - 4-Port EMI Filter

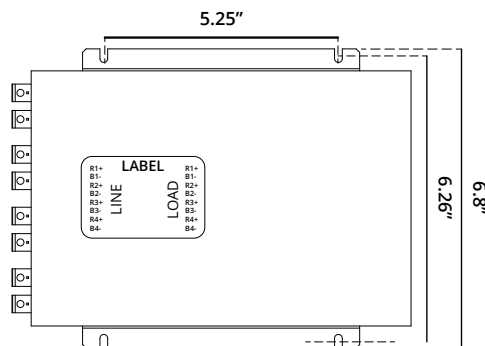
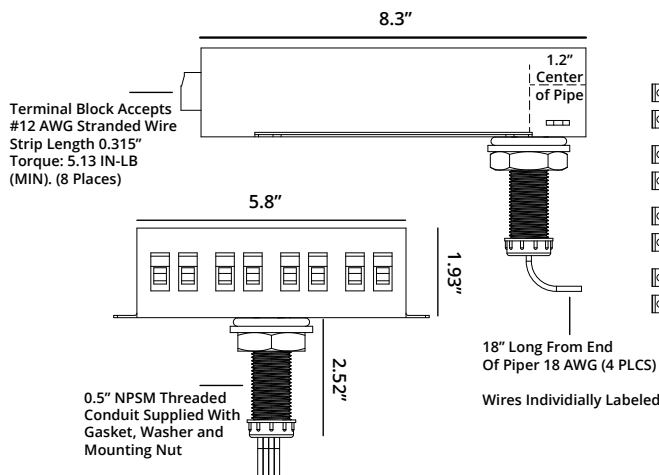

#### ELECTRICAL SCHEMATIC

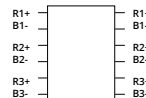

Vantage reserves the right to change components, finishes or design details in any manner which does not alter the installed appearance or reduce performance and intended function.

vHealth® is a registered trademark of Lexington Lighting Group, LLC dba Vantage Lighting