

Part #	Prepared By
Project	Notes
Type	
Date	



TUCM vHealth® Under Cabinet Medical Grade

LED Under Cabinet Light 700-4600 Lumens



Description

vHealth® TUCM LED is a specification grade, Flat lens diffuser of ribbed white acrylic snaps in or out for easy maintenance. LED Luminaire which provides smooth and uniform ambient lighting for all commercial, health care and residential applications.

Warranty & Notes

ELECTRICAL SYSTEM

- 700-4600 lumens
- 80CRI, 3000K, 3500K, 4000K, 5000K CCT
- 120V-277V / 50-60Hz
- Minimum 50,000 hours lifetime
- Antimicrobial paint
- Power factor >0.9

OPTICS & OPTIONS

- Matte white acrylic resin lens is designed to optimize light distribution.
- Optional impact resistant 50% DR white acrylic lens.
- Fixture length options: 12", 18", 24", 36" and 48".
- Varies length in 1' Increments for cord and plug, rocker switch, occupancy sensor, pull chain and grounded convenience outlet, etc.

FRAME & MOUNTING

- Cold rolled 22 gauge steel.
- Surface Mount
- Simple mounting method and direct wiring for a hassle free installation.
- White anti-microbial paint standard
- Easy to clean

DIMENSIONS

- 12L - 12"L x 4 1/2"W x 1 5/16"H
- 18L - 18"L x 4 1/2"W x 1 5/16"H
- 24L - 24"L x 4 1/2"W x 1 5/16"H
- 36L - 36"L x 4 1/2"W x 1 5/16"H
- 48L - 48"L x 4 1/2"W x 1 5/16"H

Listings

Warranty & Notes

- 5-year limited warranty on LED module and driver

Ordering Information

EXAMPLE: TUCM-24LT15W-DMV-30K-AMWH

TUCM		-		-		-		-		-	
------	--	---	--	---	--	---	--	---	--	---	--

Series	Lens	Size and Wattage	Driver	Kelvin (CCT)	Finish	Accessories*
TUCM	Blank - Matte white acrylic resin lens IR - Matte white impact resistant 50% DR white acrylic lens	12L - 12" Length, T7W - 700 Lumens T12W - 1200 Lumens	DMV - 0-10V Dimming 120-277V D1MV - 0-10V Dimming Dim to 1% 120-277V G120 - ELV/Triac Dimming at 120V only	30K - 3000K 80CRI 35K - 3500K 80CRI 40K - 4000K 80CRI 50K - 5000K 80CRI 930K - 3000K 90CRI 935K - 3500K 90CRI 940K - 4000K 90CRI	AMWH - Antimicrobial Paint White	OSF10 - Occupancy Sensor SW - Rocker Switch PC - Pull Chain GCO - Grounded Convenience Outlet CS8515P - 5-15P 120V 8ft Cord & Plug CS8L715P - L7-15P 277V 8ft Cord & Plug
		18L - 18" Length, T11W - 1100 Lumens T16W - 1600 Lumens				
		24L - 24" Length, T15W - 1500 Lumens T22W - 2200 Lumens				
		36L - 36" Length, T22W - 2200 Lumens T34W - 3400 Lumens				
		48L - 48" Length, T29W - 2900 Lumens T46W - 4600 Lumens				

Vantage reserves the right to change components, finishes or design details in any manner which does not alter the installed appearance or reduce performance and intended function.

vHealth® is a registered trademark of Lexington Lighting Group, LLC dba Vantage Lighting

TUCM vHealth® Under Cabinet Medical Grade

LED Under Cabinet Light 700-4600 Lumens

vHealth®
LIGHTING

Dimensional Data

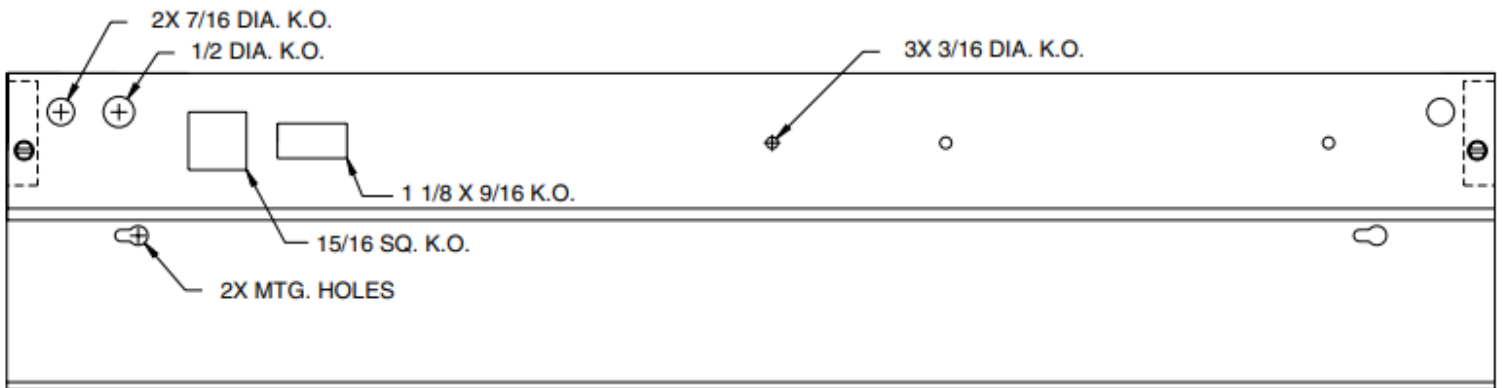
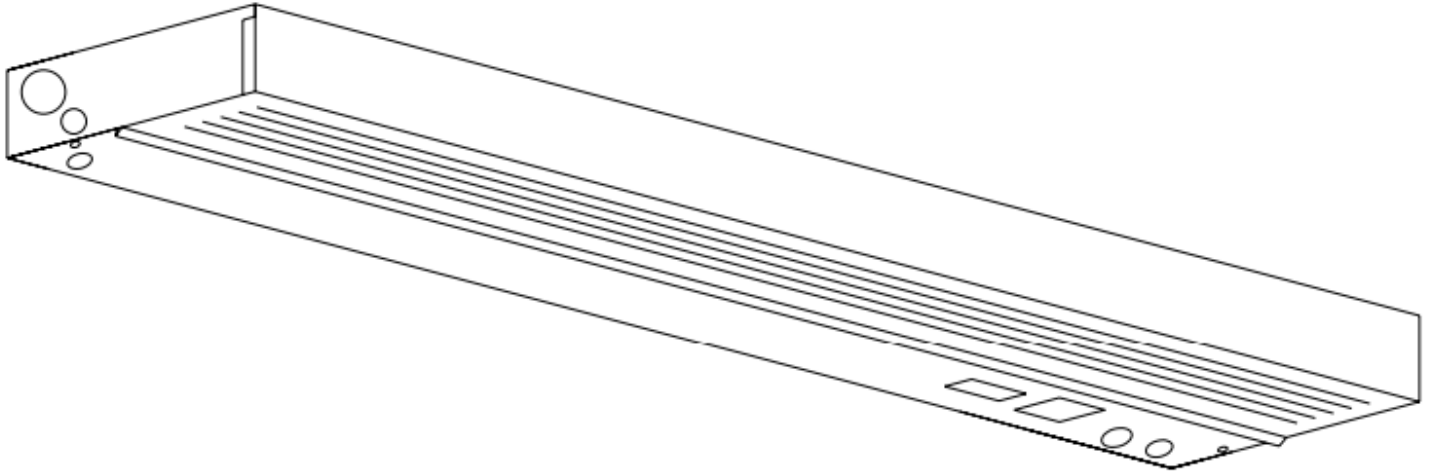

TOP
WITHOUT LENS

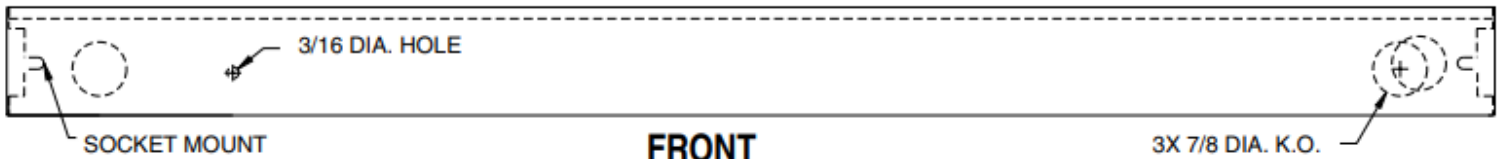

FRONT

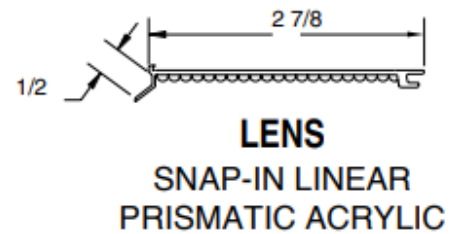
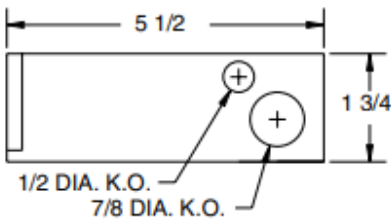

LENS
SNAP-IN LINEAR
PRISMATIC ACRYLIC

Vantage reserves the right to change components, finishes or design details in any manner which does not alter the installed appearance or reduce performance and intended function.

vHealth® is a registered trademark of Lexington Lighting Group, LLC dba Vantage Lighting

Photometrics

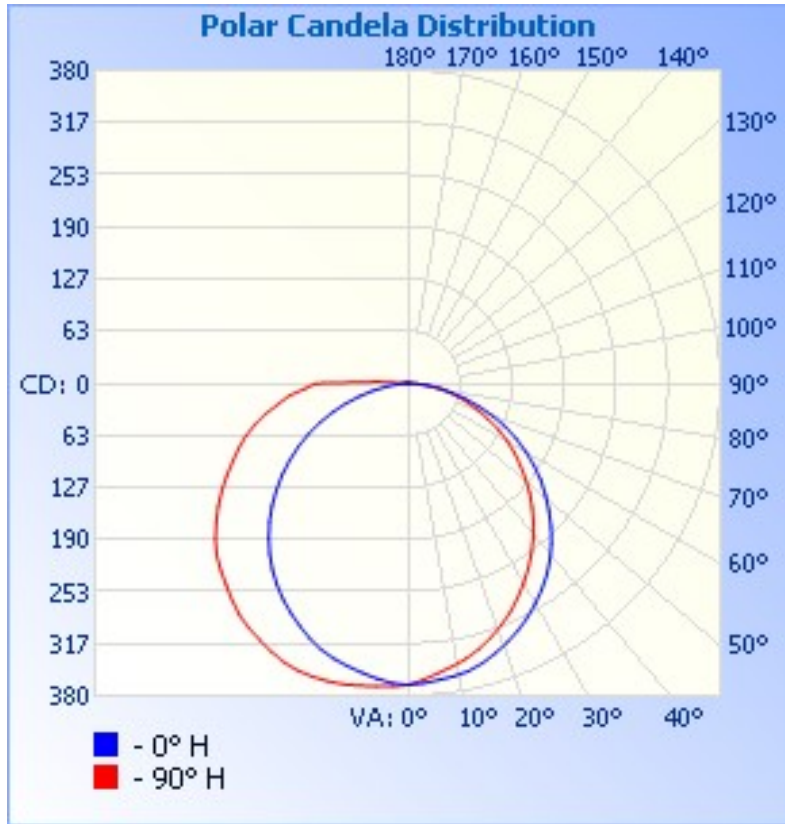

Illuminance at a Distance

	Center Beam fc	Beam Width	
1.7ft	127 fc	5.5 ft	6.7 ft
3.3ft	33.7 fc	10.7 ft	13.0 ft
5.0ft	14.7 fc	16.2 ft	19.7 ft
6.7ft	8.16 fc	21.7 ft	26.4 ft
8.3ft	5.32 fc	26.9 ft	32.7 ft
10.0ft	3.66 fc	32.4 ft	39.4 ft

■ Vert. Spread: 116.7°
■ Horiz. Spread: 126.2°

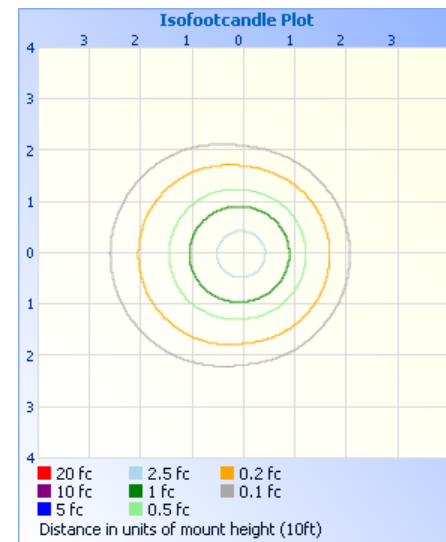

Coefficients Of Utilization - Zonal Cavity Method

Effective Floor Cavity Reflectance: 20%

RCC %:	80			70			50			30			10			0		
RW %:	70	50	30	0	70	50	30	0	50	30	20	50	30	20	50	30	20	0
RCR: 0	1.19	1.19	1.19	1.19	1.16	1.16	1.16	.99	1.11	1.11	1.11	1.06	1.06	1.06	1.01	1.01	1.01	.99
1	1.07	1.01	.96	.92	1.04	.99	.94	.80	.94	.91	.87	.90	.87	.84	.86	.84	.82	.79
2	.96	.87	.80	.73	.94	.85	.78	.66	.81	.76	.70	.78	.73	.69	.75	.71	.67	.65
3	.87	.76	.67	.60	.85	.74	.66	.55	.71	.64	.58	.68	.62	.57	.65	.60	.56	.54
4	.80	.67	.58	.50	.77	.66	.57	.47	.63	.55	.49	.60	.54	.48	.58	.52	.48	.45
5	.73	.60	.50	.43	.71	.58	.50	.41	.56	.48	.42	.54	.47	.42	.52	.46	.41	.39
6	.68	.54	.44	.37	.65	.53	.44	.36	.51	.43	.37	.49	.42	.36	.47	.41	.36	.34
7	.63	.48	.39	.33	.61	.48	.39	.32	.46	.38	.32	.44	.37	.32	.43	.37	.32	.30
8	.58	.44	.35	.29	.57	.43	.35	.28	.42	.34	.29	.41	.34	.29	.39	.33	.28	.26
9	.54	.40	.32	.26	.53	.40	.32	.25	.39	.31	.26	.37	.31	.26	.36	.30	.26	.24
10	.51	.37	.29	.24	.50	.37	.29	.23	.36	.28	.24	.35	.28	.23	.34	.28	.23	.21

Vantage reserves the right to change components, finishes or design details in any manner which does not alter the installed appearance or reduce performance and intended function.

vHealth® is a registered trademark of Lexington Lighting Group, LLC dba Vantage Lighting